

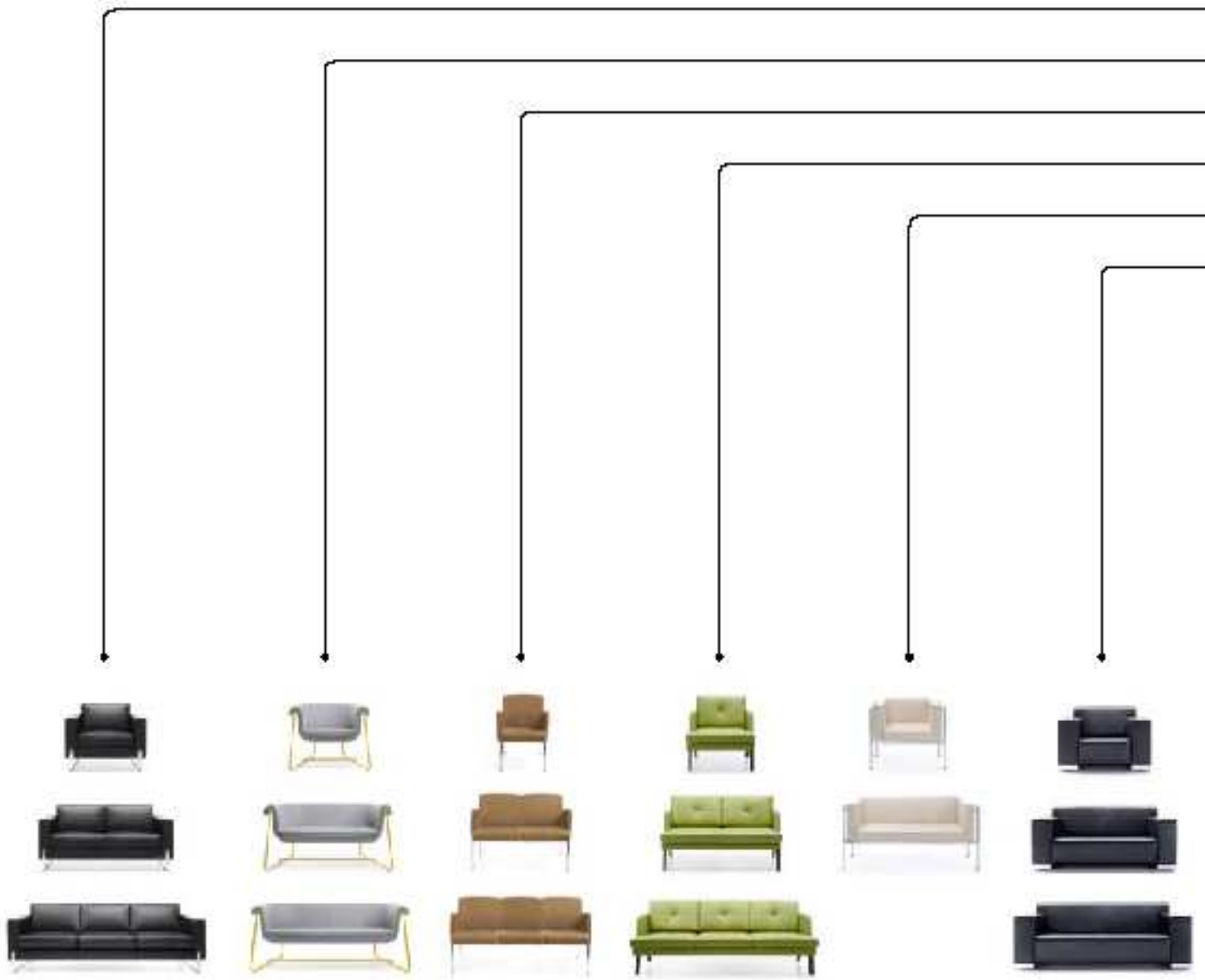

SYSTEMY RECEPCYJNE

 **PROFI**



**EXEC SOFA**  
Design:  
Paul Brooks



**HOVER, SEVEN, WALL IN**  
Design: Tomasz Rygalki  
Studio: Rygalki



**KOKO**  
Design:  
Tomasz Augustyniak



**OCTOBER**  
Design:  
Hilary Birksok



**TRADE RA**  
Design:  
Ronald Graubal



**VANCOUVER,  
SEATTLE**  
Design: FDT

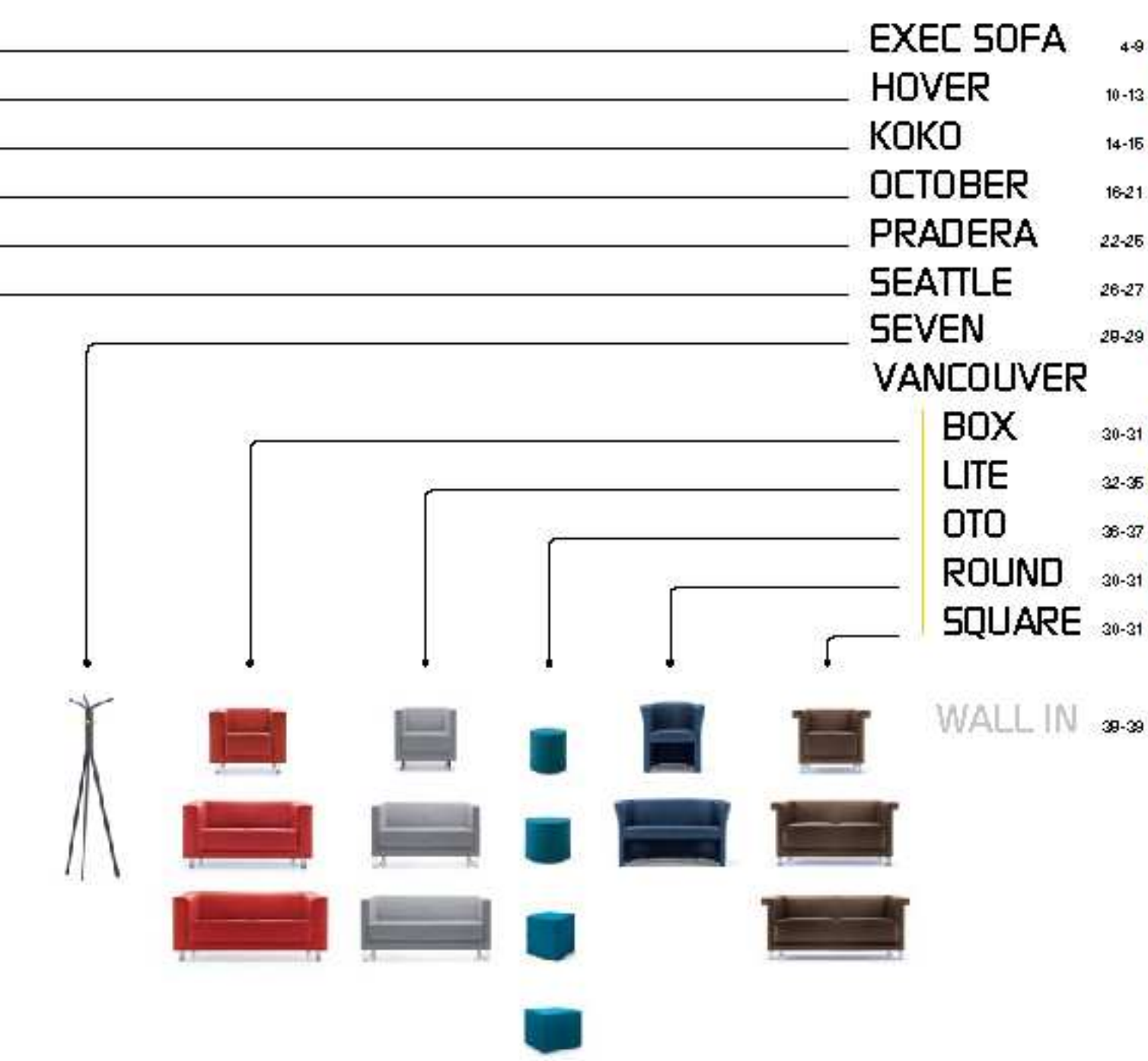

**CHROMIUM III**  
 Tahan lama, tahan panas, tahan air, tahan minyak.  
 Mudah dibersihkan, tahan lama, tahan air, tahan minyak.  
[www.chromium.com](http://www.chromium.com)

**CHROMIUM III**  
 Benar-Benar by Technology  
 Produk pilihan untuk interior rumah.

**5 YEARS GUARANTEE**  
 5 TAHUN GARANSI



## EXEC SOFA

na wasec





EXEC SOFA









Dwie wersje  
słazi  
*Two versions  
of frame*



## EXEC SOFA

nowa



EXEC SOFA 20H SATYNA



EXEC SOFA 10H SATYNA



EXEC SOFA 20H SATYNA

Trzy wersje siedziak:  
fotel, sofa dwu i trzy-  
osobowa  
*Three versions:  
armchair, two and  
three-seater sofa*



EXEC SOFA 10V CHROM



EXEC SOFA 10V CHROM



EXEC SOFA 20V CHROM

Stoliki dostępne  
w dwóch rozmiarach  
oraz dwóch wersjach  
słazi  
*Tables available  
in two sizes and two  
versions of frame*



EXEC STOLIK S2 H SATYNA  
*EXEC TABLE S2 H SATINE*



EXEC STOLIK S1 V CHROM  
*EXEC TABLE S1 V CHROME*



HOVER





HOVER 26 RAL 6018

HOVER S 1 RAL 6018

CHROM CHROME	SATYNA SATINE	METALIK METALLO	CZARNY BLACK	RAL 6018 (TURKUS) RAL 6018 (TURQUOISE)	RAL 1023 (ZOLTY) RAL 1023 (YELLOW)	RAL 3018 (CZERWONY) RAL 3018 (RED)	RAL 9003 (BIALY) RAL 9003 (WHITE)





## HOVER



HOVER 20 RAL 1023



HOVER S1 RAL 601B



HOVER S2 RAL 1023

Stoliki HOVER  
dostępne w trzech  
rozmiarach  
*HOVER tables  
available in three  
sizes*



HOVER S3 SATYNA



HOVER 10 RAL 9003



HOVER 10 SATYNA





KOKO 1HECHROMSTO7M



KOKO 1HECHROMSTO7M

W wersji na stopkach a rotator posiada funkcję pamięci, która umożliwia powrót do pozycji wyjściowej ustawienia fotela.  
*In version with glides the gaslift is equipped with memory thanks to which the armchair returns to its previous position.*



KOKO 1HECHROMKÓŁKA

Dwa rodzaje kółek do różnych nawierzchni.  
*Two types of castors for different surfaces.*



Lawki / fotele z podłokietnikami lub bez  
*Benches / armchairs with or without armrests*



KOKO 1FCHROM



KOKO 2FCHROM



KOKO 3FCHROM



KOKO STOLIK S3CHROM  
KOKO TABLE S3CHROME



KOKO STOLIK S2CHROM  
KOKO TABLE S2CHROME



KOKO STOLIK S1CHROM  
KOKO TABLE S1CHROME

**P**  
podłokietnik palny  
full armrest



KOKO 1F CHROM

**H**  
podłokietnik metalowy  
z nakładką drewnianą  
metal armrest with  
wooden pad



KOKO 1H CHROM

**U**  
uchwyt do blatu  
handle for table



KOKO 1ULC CHROM



przeowanie do blatu  
handle for table top adapters

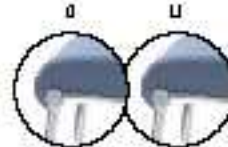

brak możliwości przeowania - złącze  
without handle for table top adapters - plug

**KOKO**

KOKO 3ULC CHROM

KOKO BLATE2  
KOKO TABLE TOP B2

KOKO 1UK CHROM

KOKO BLATE2  
KOKO TABLE TOP B2

KOKO 2UK CHROM

KOKO BLATE1  
KOKO TABLE TOP B1

KOKO 1UF CHROM



Przy pomocy łączników  
KOKO BLAT B1, B2 lub B3  
można tworzyć różne układy  
Wide range of combinations  
with help of desk connectors

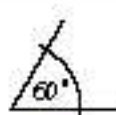

KOKO BLATE3  
KOKO TABLE TOP B3

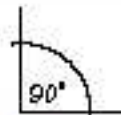

KOKO BLATE2  
KOKO TABLE TOP B2



KOKO BLATE1  
KOKO TABLE TOP B1

Blaty łączące  
Table connectors







OCTOBER





OCTOBER





nowość

OCTOBER



OCTOBER 11 CHROM



OCTOBER 11 WOOD



OCTOBER 11 WOOD



OCTOBER 21 CHROM

Dwie wersje nóg:  
metalowe i drewniane  
*Two versions of legs,  
metal and wooden*



OCTOBER 31 WOOD



OCTOBER STOLIK S2 CHROM 61  
OCTOBER TABLE S2 CHROM 61

Stoliki dostępne  
w dwóch rozmiarach,  
dwóch wersjach nóg  
oraz dwóch typach  
blatów  
*Tables available in two  
sizes, two versions of  
legs and two versions  
of table top*



OCTOBER STOLIK S2 WOOD  
OCTOBER TABLE S2 WOOD



OCTOBER STOLIK S1 WOOD 81  
OCTOBER TABLE S1 WOOD 81



OCTOBER 10 CHROM



OCTOBER 10 WOOD



OCTOBER 20 WOOD



FRADERA 11 UL CHROM

FRADERA ELATE1  
FRADERA TABLE TO P BY



FRADERA 10 UL CHROM

# PRADERA

TRADERA 11 UK CHROM

TRADERA BLATE3  
PRADERA TABLE TOP 85

TRADERA 11 UF CHROM



Błaty łączące  
Desk connectors

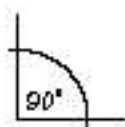
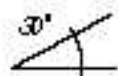

PRADERA BLAT B2  
PRADERA TABLE TOP B2



PRADERA BLAT B3  
PRADERA TABLE TOP B3



PRADERA BLAT B1  
PRADERA TABLE TOP B1

Przy pomocy blatów łączących PRADERA BLAT B1, B2 i B3  
można tworzyć różne układy  
Wide range of combinations thanks to linking table tops







PRADERA STOLIK S3  
występuje także w wersji  
ze szklanym blatem (S1)  
PRADERA TABLE S3 is also  
available with glass  
table top (S1)

## PRADERA

PRADERA występuje w wersji jedno i dwuosobowej  
PRADERA is available in one and two-seater



FRADERA 110 CZARNY

FRADERA 110 CZARNY

FRADERA 210 CZARNY

FRADERA 210 CZARNY

Kolory stelaża  
Colours of frames



SATYNA  
SATINE



CHROM  
CHROME



METALIK  
METALLIC



CZARNY  
BLACK



FRADERA STOLIK S4  
PRADERA TABLE S4



SEATTLE 20 C H R O M



SEATTLE 26 C H R O M



SEATTLE



SEATTLE 10 CHROM





SEVEN

Możliwość dowolnego  
łączenia koloru  
stelaża z kolorem  
haczyków  
*Possibility of joining  
any frame and any  
hook colours*

VANCOUVER  
BOX



VB1



VB2



VR1



VANCOUVER  
SQUARE



VS1





VE2,6



VR2



VANCOUVER

BOX

ROUND  
SQUARE



VE2



VE2,6



VANCOUVER S TOUK S3 SATYNA  
VANCOUVER TABLE S3 SATINE



VANCOUVER S TOUK S2 SATYNA  
VANCOUVER TABLE S2 SATINE



VANCOUVER S TOUK S1 CHROME  
VANCOUVER TABLE S1 CHROME







VANCOUVER  
LITE



VL1 V CHROM

VL2 V CHROM



VL1 V CHROM



VL2 V CHROM



VL1 H CHROM



VL1 H CHROM



VL2,6 H CHROM





VANCOUVER  
**LITE**





VLS II CROM



VO R2



VO R2



VOB2



Purty kwadratowe  
 i okrągłe w dwóch  
 rozmiarach  
*Squares round and  
 square in two sizes*



V0S2



V0S1



V0R2



V0R1

**VANCOUVER**  
**OTO**

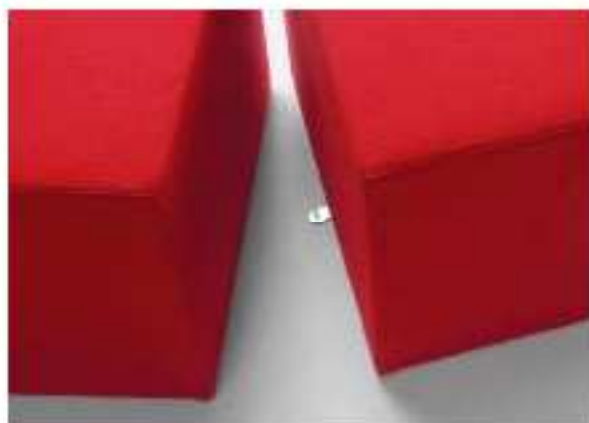

Możliwość łączenia  
 elementów w wersji  
 V0S  
*Possibility of joining  
 V0S version*

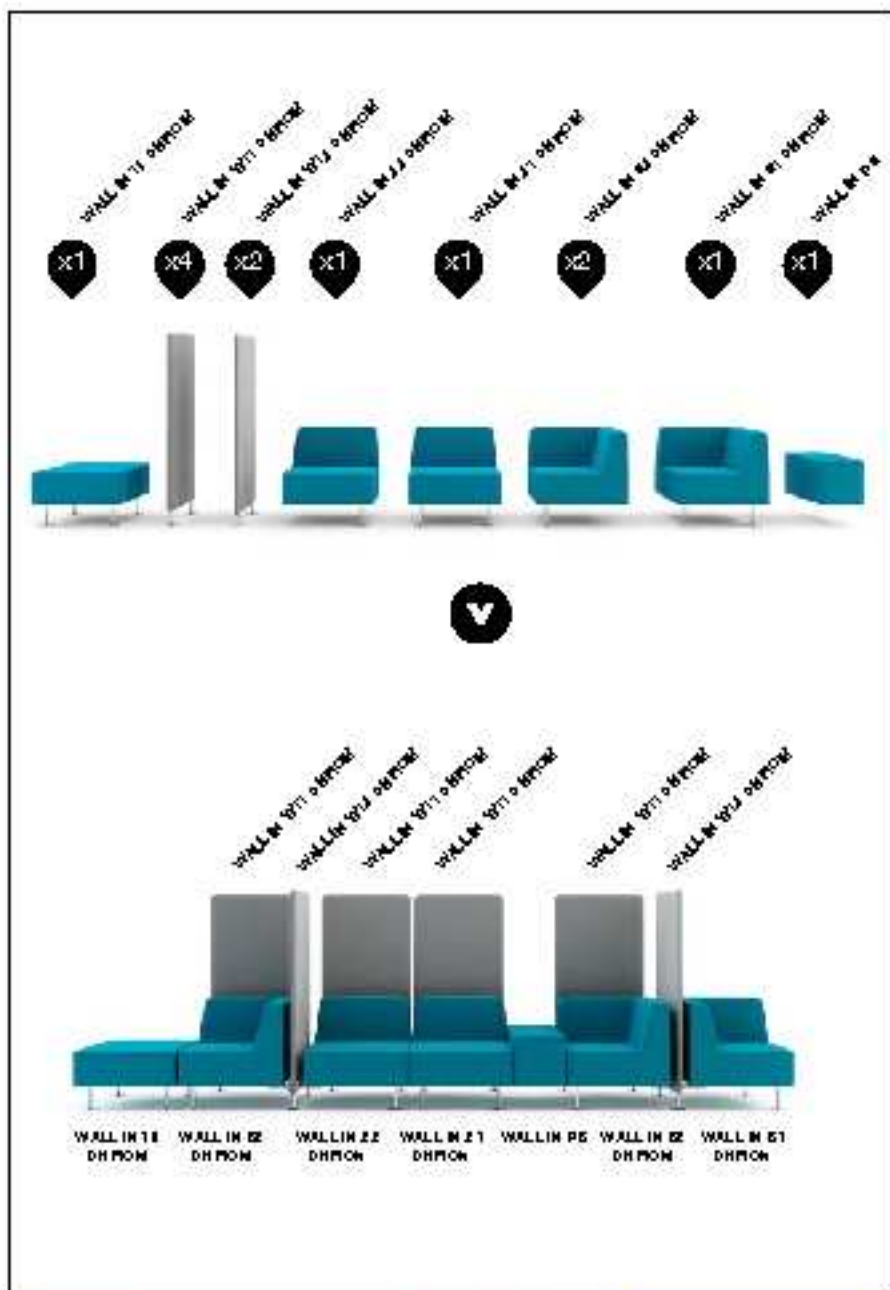

Stwórz swój własny system  
 Create Your own system





# WALL IN

Więcej informacji znajdziesz  
w katalogu produktowym WALL IN  
*More informations in WALL IN catalogue*



**EXEC SOFA** str. 4-9

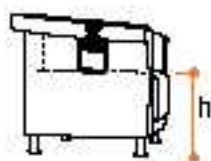
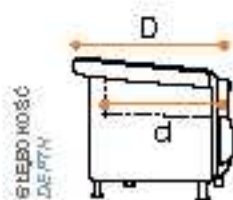
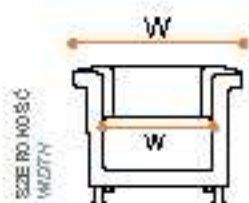
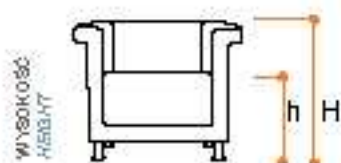

Wysokość siedziska  
Wysokość siedziska zmierzona z bezstopnia.  
Wysokość siedziska zmierzona z szczytu  
zaczepu PN EN 14781 (zob. rysunek).  
Seat height  
Seat height is measured with out casters.  
Seat height is measured with out  
PN EN 14781 (with casters).



**EXEC SOFA 10V / 10H**  
H 758 / W 928 / D 658  
h 458 / w 858 / d 558  
h° 488



**EXEC SOFA 20V / 20H**  
H 758 / W 1678 / D 658  
h 458 / w 1528 / d 558  
h° 488



**EXEC SOFA 30V / 30H**  
H 758 / W 2228 / D 658  
h 458 / w 2078 / d 558  
h° 488

**HOVER** str. 10-13



**HOVER 10**  
H 788 / W 878 / D 758  
h 498 / w 808 / d 478  
h° 488



**HOVER 20**  
H 788 / W 1678 / D 758  
h 498 / w 1528 / d 478  
h° 488



**HOVER 25**  
H 788 / W 1828 / D 758  
h 498 / w 1678 / d 478  
h° 488

**KOKO** str. 14-15



**KOKO 1U**  
KOKO 1C  
H 848 / W 658 / D 718  
h 458 / w 588 / d 538  
h° 488



**KOKO 2U**  
KOKO 2C  
H 848 / W 1358 / D 718  
h 458 / w 1188 / d 538  
h° 488



**KOKO 3U**  
KOKO 3C  
H 848 / W 1808 / D 718  
h 458 / w 1638 / d 538  
h° 488

**KOKO** str. 14-15

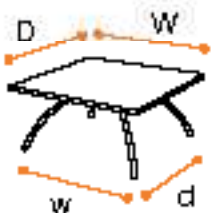

**KOKO 2I**  
H 848 / W 1218 / D 718  
h 458 / w 1188 / d 538  
h° 488



**KOKO 3I**  
H 848 / W 1768 / D 718  
h 458 / w 1638 / d 538  
h° 488



**KOKO 1HE**  
H 858-948 / h 558-648  
W 658 / D 718, h° 488-578  
h 478-568 / h 488-578  
w 558 / d 538, h° 488-578





**EXEC STOLIK S2 H**  
*EXEC TABLE S2 H*  
 H 48 / W 88 / D 88  
 w 88 / d 88



**EXEC STOLIK S1 H**  
*EXEC TABLE S1 H*  
 H 48 / W 128 / D 88  
 w 118 / d 88



**EXEC STOLIK S2 V**  
*EXEC TABLE S2 V*  
 H 48 / W 88 / D 88  
 w 78 / d 88



**EXEC STOLIK S1 V**  
*EXEC TABLE S1 V*  
 H 48 / W 128 / D 88  
 w 118 / d 88



**HOVER S3**  
 H 44 / W 48 / D 48  
 w 44 / d 48



**HOVER S2**  
 H 57 / W 88 / D 88  
 w 78 / d 88



**HOVER S1**  
 H 57 / W 128 / D 74  
 w 118 / d 88



**KOKO 1H**  
 H 84 / W 88 / D 78  
 h 48 / w 88 / d 88  
 h" 48



**KOKO 2H**  
 H 84 / W 128 / D 78  
 h 48 / w 118 / d 88  
 h" 48



**KOKO 3H**  
 H 84 / W 178 / D 78  
 h 48 / w 168 / d 88  
 h" 48



**KOKO 1V**  
 H 84 / W 88 / D 78  
 h 48 / w 88 / d 88  
 h" 48



**KOKO 1VE**  
 H 84 / W 88 / H 88-108  
 W 88 / D 78, h" 48-58  
 h 48-58 / h 48-58  
 w 88 / d 88, h" 48-58



**KOKO STOLIK S3**  
*KOKO TABLE S3*  
 H 48 / W 78 / D 78  
 w 78 / d 78



**KOKO STOLIK S2**  
*KOKO TABLE S2*  
 H 48 / W 88 / D 88  
 w 88 / d 88



**KOKO STOLIK S1**  
*KOKO TABLE S1*  
 H 48 / W 128 / D 88  
 w 118 / d 88

OCTOBER str. 18-21

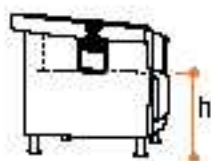
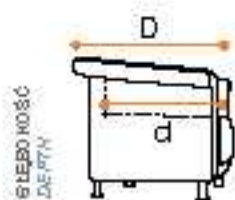
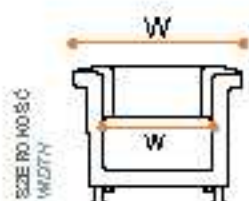
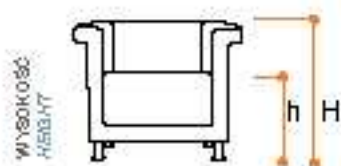

Wysokość siedziska  
 Wysokość siedziska zmiernie a bez balastera.  
 \*Wysokość siedziska zmiernie a zgięte le  
 ze armaj PN EN 14781 (cała tyłem).  
 Seat height  
 Seat height is measured with/without armrests.  
 \*Seat height is measured according to  
 PN EN 14781 (with seat backrest).



OCTOBER 11  
 H 848 / W 728 / D 848  
 h 448 / w 708 / d 828  
 h" 481



OCTOBER 21  
 H 848 / W 1418 / D 848  
 h 448 / w 1418 / d 828  
 h" 481



OCTOBER 31  
 H 848 / W 2178 / D 848  
 h 448 / w 2178 / d 828  
 h" 481

PRADERA str. 22-25



PRADERA 11  
 H 828 / W 918 / D 728  
 h 428 / w 878 / d 428  
 h" 481



PRADERA 21  
 H 828 / W 1838 / D 728  
 h 428 / w 1798 / d 428  
 h" 481



PRADERA 10  
 H 428 / W 918 / D 728  
 h 428 / w 728  
 h" 481

SEATTLE str. 26-27



SEATTLE 10  
 H 728 / W 1118 / D 828  
 h 428 / w 878 / d 828  
 h" 481



SEATTLE 21  
 H 728 / W 1718 / D 828  
 h 428 / w 1328 / d 828  
 h" 481



SEATTLE 26  
 H 728 / W 2318 / D 828  
 h 428 / w 1928 / d 828  
 h" 481

VANCOUVER BOX str. 30-31

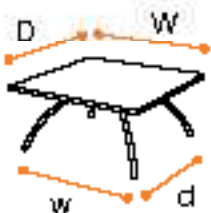

VB1  
 H 778 / W 828 / D 728  
 h 448 / w 808 / d 648  
 h" 481



VB2  
 H 778 / W 1428 / D 728  
 h 448 / w 1388 / d 648  
 h" 481



VB2,6  
 H 778 / W 1828 / D 728  
 h 448 / w 1788 / d 648  
 h" 481



**OCTOBER 10**  
 H 44 / W 578 / D 578  
 h 44 / w 578 / d 578  
 n° 483



**OCTOBER R20**  
 H 44 / W 1618 / D 578  
 h 44 / w 1618 / d 578  
 n° 483



**OCTOBER R STOLIK S2**  
*OCTOBER TABLE S2*  
 H 228 / W 588 / D 588  
 w 588 / d 588



**OCTOBER STOLIK S1**  
*OCTOBER TABLE S1*  
 H 228 / W 1288 / D 588  
 w 1288 / d 588



**PRADERA 20**  
 H 478 / W 1508 / D 708  
 h 478 / w 1498  
 n° 483



**PRADERA STOLIK S3**  
*PRADERA TABLE S3*  
 H 448 / W 918 / D 708  
 w 918 / d 708



**PRADERA STOLIK S4**  
*PRADERA TABLE S4*  
 H 748 / D 488  
 D 488

**SEVEN** str. 28-29

**SEVEN**  
 H 1878 /  
 W 518 /  
 D 448



**VANCOUVER LITE** str. 32-35



**VL1 V/H**  
 H 718 / W 788 / D 888  
 h 448 / w 598 / d 488  
 n° 483



**VL2 V/H**  
 H 718 / W 1208 / D 888  
 h 448 / w 1078 / d 488  
 n° 483



**VL26 V/H**  
 H 718 / W 1688 / D 888  
 h 448 / w 1618 / d 488  
 n° 483

VANCOUVER OTO str. 30-31

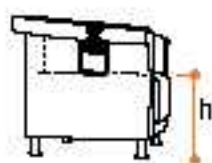
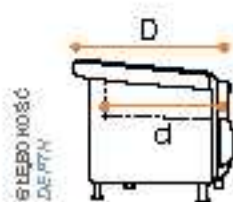
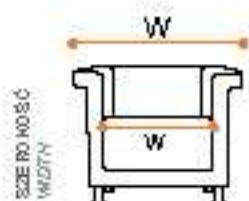
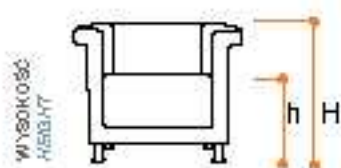

Wysokość siedziska  
Wysokość siedziska zmiernie a bez talabala.  
Wysokość siedziska zmiernie a zge de le  
ce ermaq PN EN 14781 (ce ba tybalet-em).  
Seat height  
Seat height is mea ased with ut seat ounlet.  
Seat height from seated's ce asing to  
PN EN 14781 (with seat ounlet).

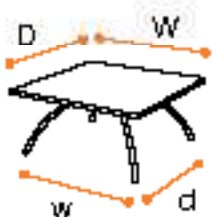
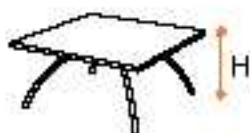

VO R1  
H 48 / W 48 / D 54  
h" 48



VO R2  
H 48 / W 48 / D 48  
h" 48



VO S1  
H 48 / W 54 / D 54  
h" 48

VANCOUVER SQUARE str. 30-31



VS1  
H 78 / W 88 / D 78  
h 48 / w 54 / d 52  
h" 48



VS2  
H 78 / W 168 / D 78  
h 48 / w 118 / d 52  
h" 48



VS2.5  
H 78 / W 184 / D 78  
h 48 / w 134 / d 52  
h" 48

## VANCOUVER ROUND

str. 30-31



VO S2

H 400 / W 400 / D 400  
h" 400



VR 1

H 700 / W 700 / D 600  
h 400 / w 400 / d 600  
h" 400



VR 2

H 700 / W 1200 / D 600  
h 400 / w 1200 / d 600  
h" 400

## VANCOUVER STOLIKI

str. 30-31



VANCOUVER STOLIK S3  
VANCOUVER TABLE S3

H 400 / W 600 / D 600 mm



VANCOUVER STOLIK S2  
VANCOUVER TABLE S2

H 400 / W 1200 / D 600



VANCOUVER STOLIK S1  
VANCOUVER TABLE S1

H 400 / W 1800 / D 600

PRZY ZAMÓWIENIU PROSIMY STOSOWAĆ SYMBOLE WEDŁUG KODU:  
PLEASE USE CODES AT ORDER:

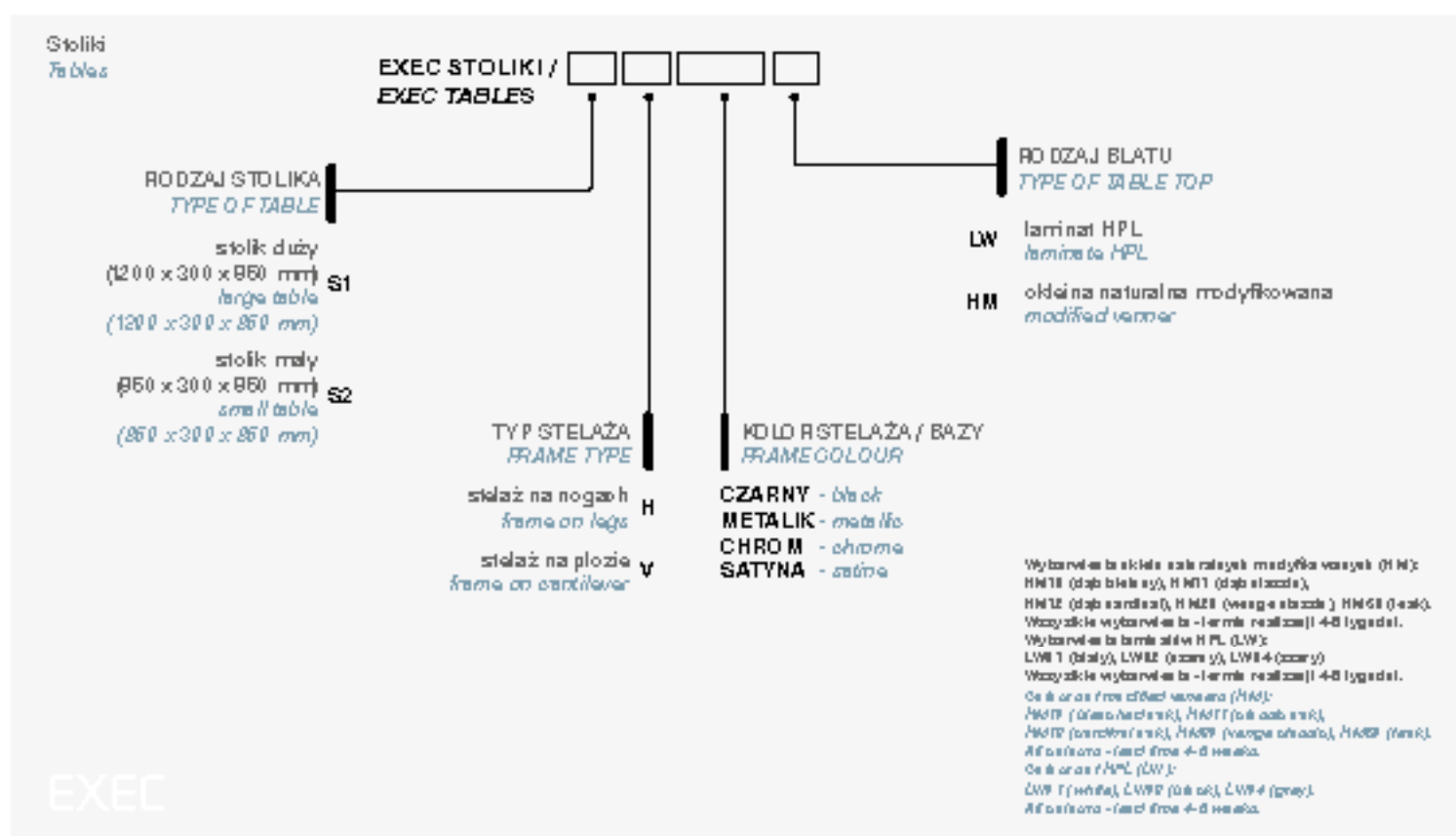
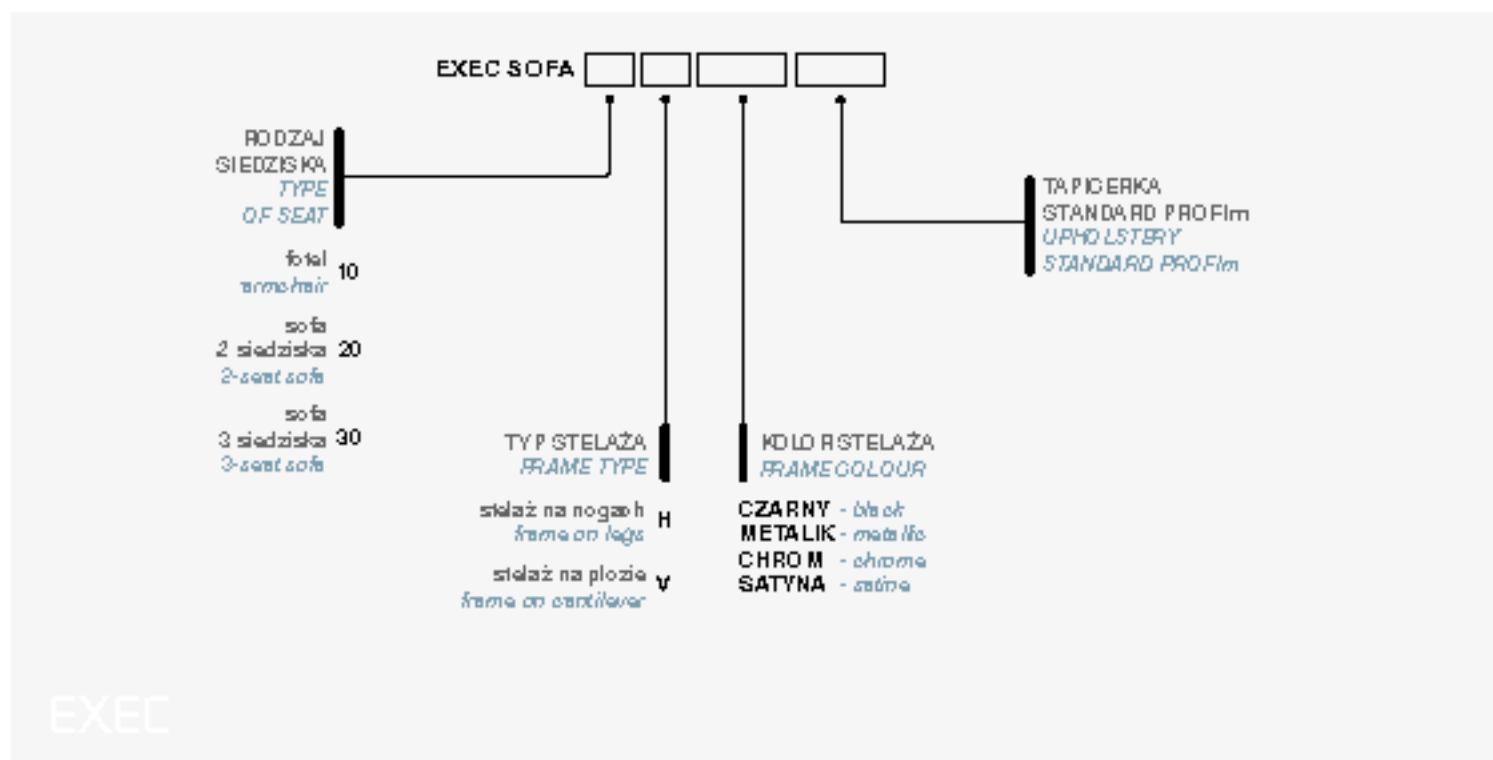

PRZY ZAMÓWIENIU PROSIMY STOSOWAĆ SYMBOLE WEDŁUG KODU:  
PLEASE USE CODES AT ORDER:

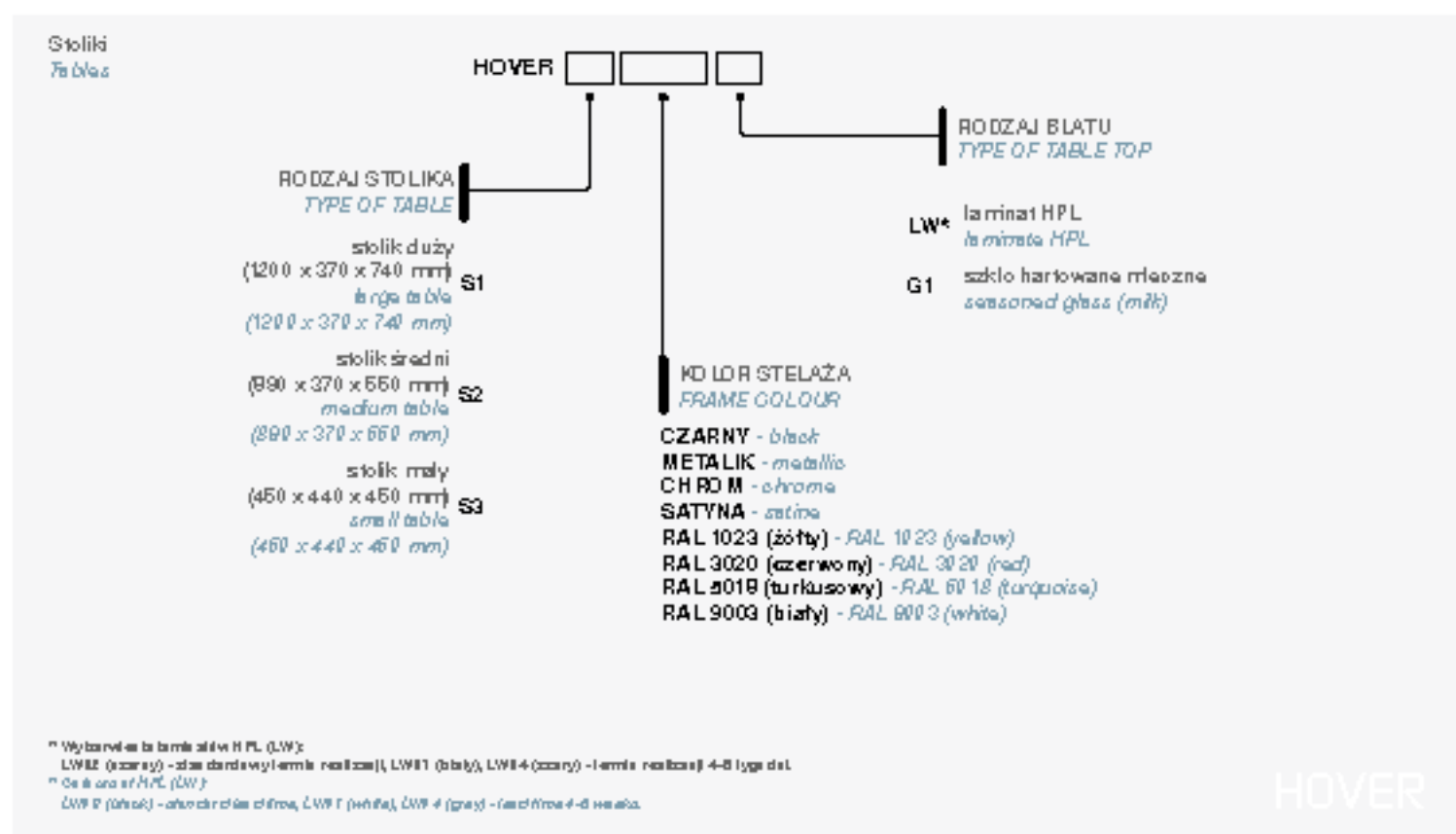
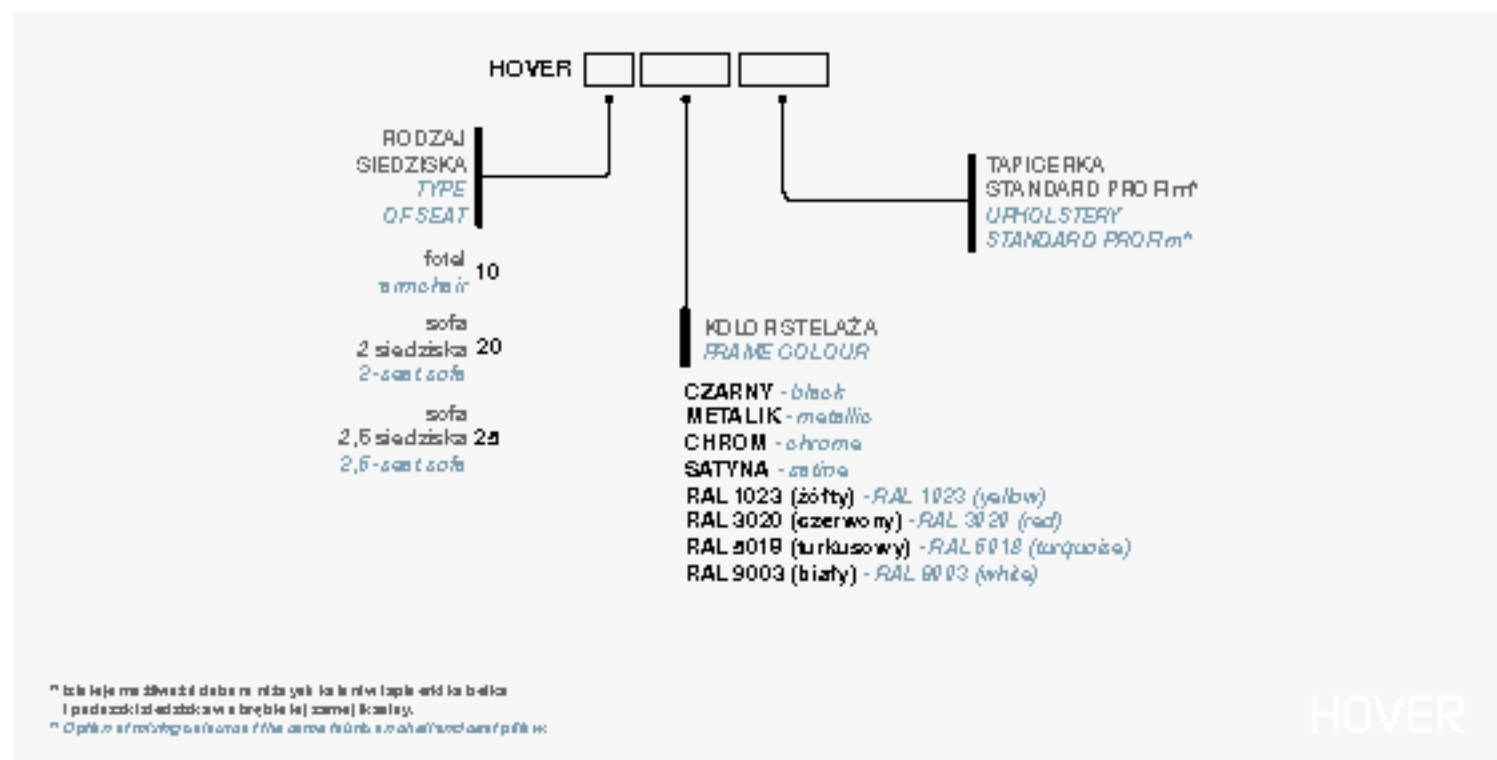

PRZY ZAMÓWIENIU PROSIMY STOSOWAĆ SYMBOLE WEDŁUG KODU:  
PLEASE USE CODES AT ORDER:

KOD WERSJA RECEPCYJNA:  
KOD RECEPTION VERSION:



KOD WERSJA OBRÓTKA:  
KOD SWIVEL VERSION:

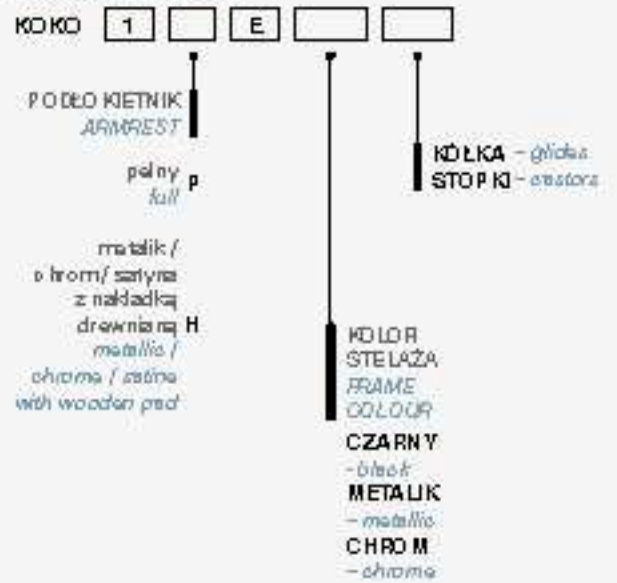



PRZY ZAMÓWIENIU PROSIMY STOSOWAĆ SYMBOLE WEDŁUG KODU:  
PLEASE USE CODES AT ORDER:

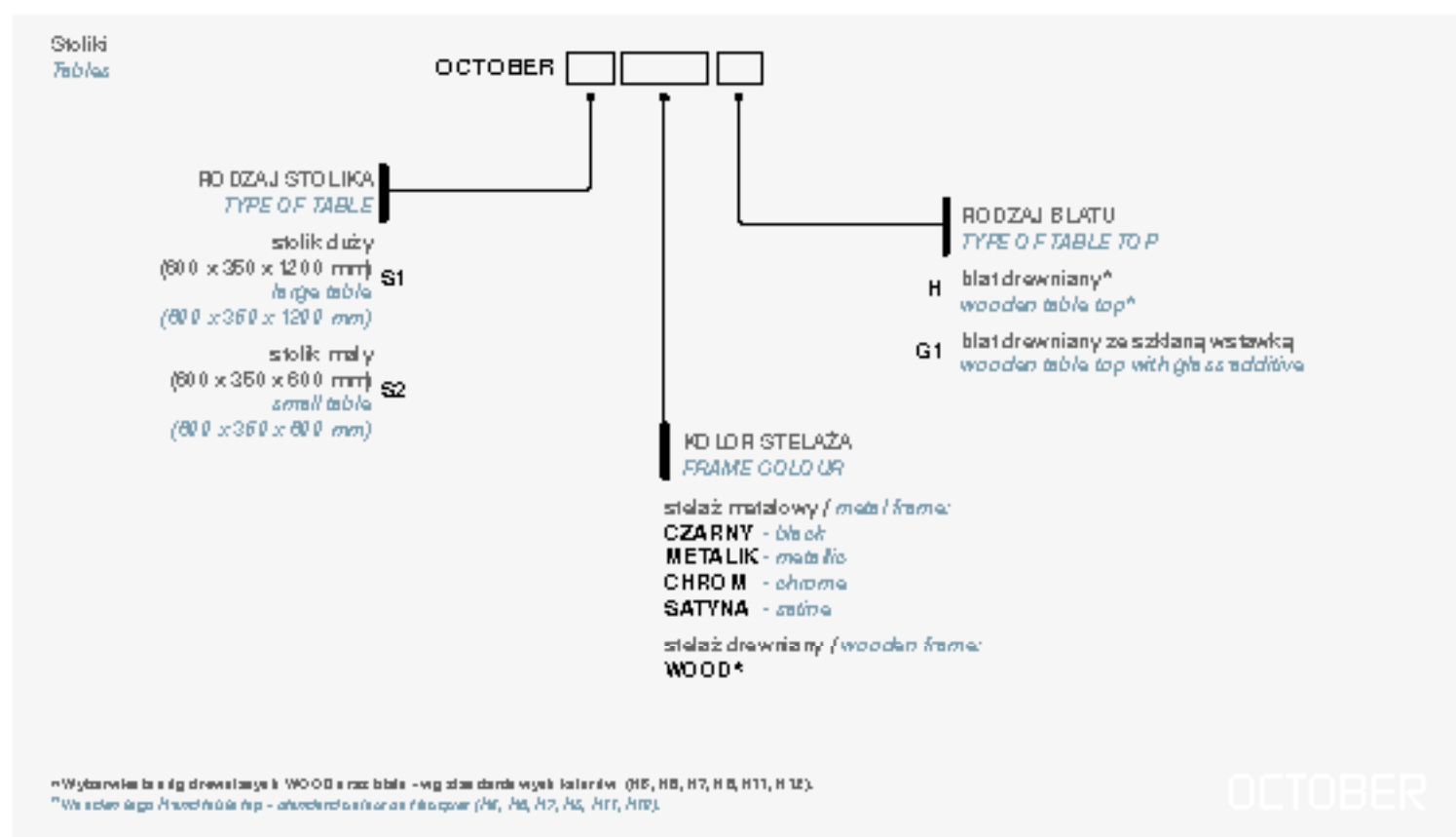
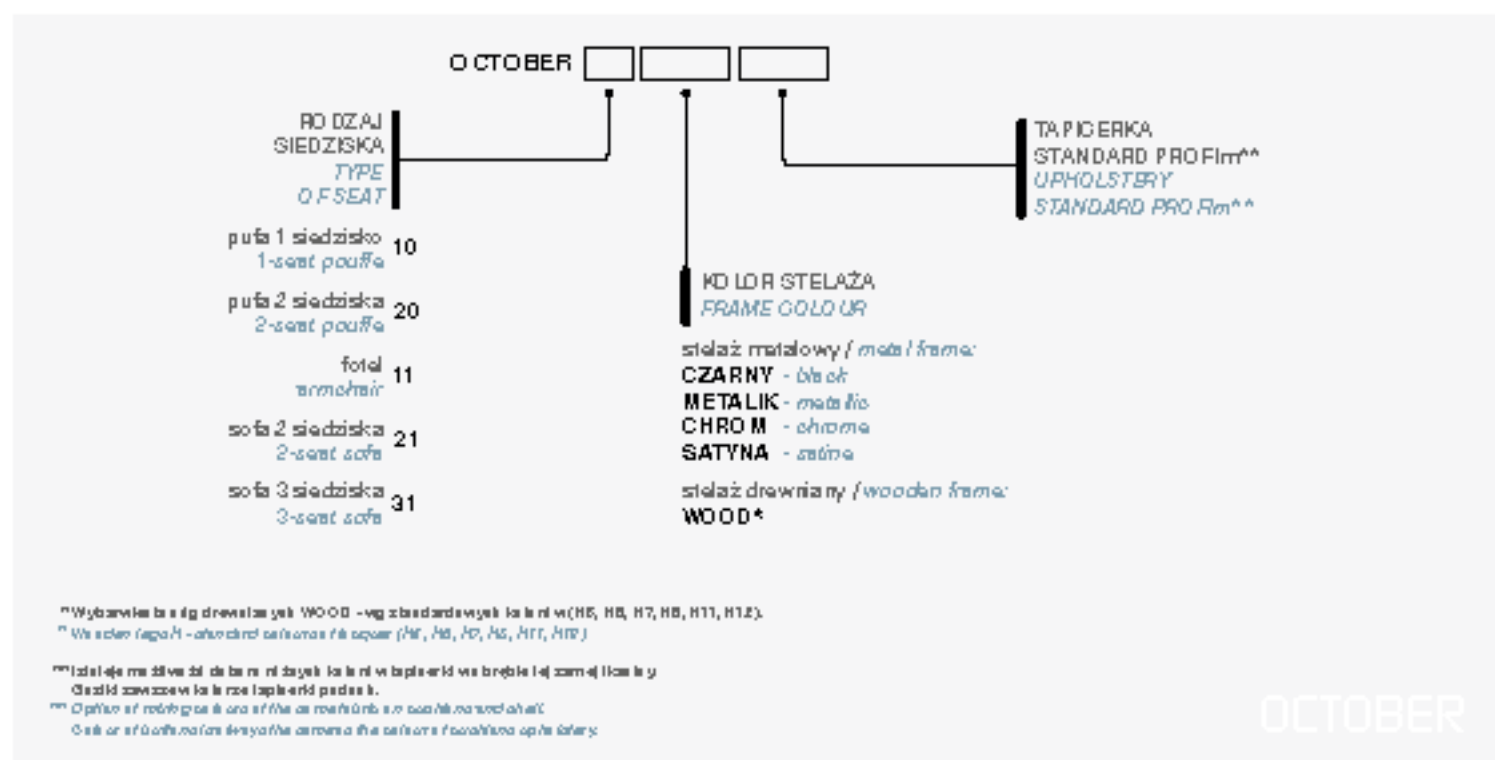

PRZY ZAMÓWIENIU PROSIMY STOSOWAĆ SYMBOLE WEDŁUG KODU:  
PLEASE USE CODES AT ORDER.

**PRADERA**

RODZAJ SIEDZISKA  
TYPE OF SEAT

fotel armchair 1  
sofa 2  
2-seset sofa 2

RODZAJ OPARCIA  
TYPE OF BACKREST

z oparciem i podłokietnikami  
with backrest and armrests 1  
bez oparcia i podłokietników  
without backrest and armrests 0

UCHWYT DO BLATU  
HANDLE FOR TABLE

UL lewostronny  
left-sided  
UP prawostronny  
right-sided  
UK obustronny  
both-sided  
UM uchwyt na blat pod kubek  
handle for tea tray table B4  
O zasłepki  
hole plugs

KOLOR STELAŻA  
FRAME COLOUR

CZARNY - czarny  
METALIK - metalic  
CHROM - chrom  
SATYNA - satyna

Stoliki  
Tables

**PRADERA**

RODZAJ STOLIKA  
TYPE OF TABLE

S3  
S4

KOLOR STELAŻA  
FRAME COLOUR

CZARNY - czarny  
METALIK - metalic  
CHROM - chrom  
SATYNA - satyna

Wybór koloru stolika w modelach S3/S4/S1/S2/S5/S4 - wg standardowej palety kolorów (R15, H15, H17, H8, H11, H12).  
Wybór koloru w modelach S4/S1/S2/S5/S4 - metaliczne kolory (H15).  
Czarna i srebrna kolorystyka PRADERA S3/S4/S1/S2/S5/S4 ma charakter alternatywny do kolorystyki (H15, H8, H10, H4, H11, H12).  
Czarna i srebrna kolorystyka PRADERA S4/S1/S2/S5/S4 ma charakter alternatywny do kolorystyki (H15).

PRADERA

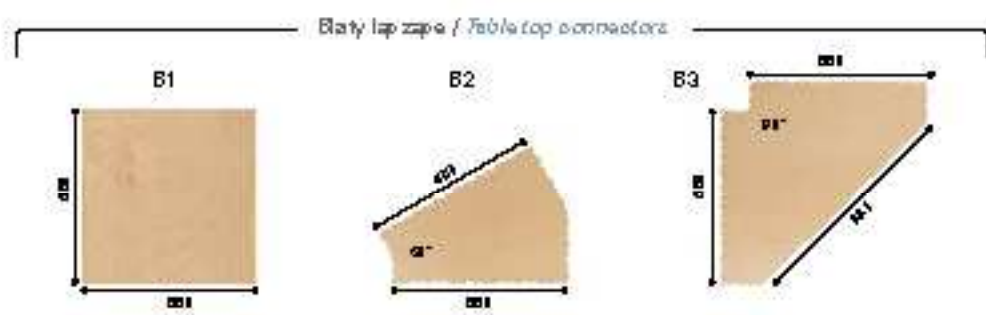

PRZY ZAMÓWIENIU PROSIMY STOSOWAĆ SYMBOLE WEDŁUG KODU:  
PLEASE USE CODES AT ORDER:

**SEVEN**

**KOLOR STELAŻA WIE SZAKA**  
*GOAT STAND FRAME COLOUR*

**CZARNY** - black  
**METALIK** - metallic  
RAL 1023 (żółty) - RAL 1023 (yellow)  
RAL 3020 (czerwony) - RAL 3020 (red)  
RAL 5018 (turkusowy) - RAL 5018 (turquoise)  
RAL 9003 (biały) - RAL 9003 (white)

**KOLOR Haczyka\***  
*HOOK COLOUR\**

**CZARNY** - black  
**METALIK** - metallic  
**CHROM** - chrome  
RAL 1023 (żółty) - RAL 1023 (yellow)  
RAL 3020 (czerwony) - RAL 3020 (red)  
RAL 5018 (turkusowy) - RAL 5018 (turquoise)  
RAL 9003 (biały) - RAL 9003 (white)

\*Istnieje możliwość zamontowania haczyków w innych kolorach i rozmiarach.  
\*It is possible to order a sofa different hooks or than the one offered here.

SEVEN

**VANCOUVER LITE**

**RODZAJ SIEDZISKA**  
*TYPE OF SEAT*

fojał  
*armchair* **VL1**

sofa 2 siedziska  
*2-seat sofa* **VL2**

sofa 2,5 siedziska  
*2,5-seat sofa* **VL2,5**

**TYP STELAŻA**  
*FRAME TYPE*

stelaż na nogach  
*frame on legs* **H**

stelaż na płozie  
*frame on casters* **V**

**KOLOR STELAŻA**  
*FRAME COLOUR*

**METALIK** - metallic  
**CHROM** - chrome  
**SATYNA** - satin

**TAPICERKA**  
*STANDARD PRO Film*  
**UPHOLSTERY**  
*STANDARD PRO Film*

VANCOUVER LITE

**VANCOUVER OTO**

**RODZAJ PUFY**  
*POUFFE TYPE*

pufka kwadratowa  
*square pouffe* **VOS**

pufka okrągła  
*round pouffe* **VOR**

**ROZMIAR PUFY**  
*POUFFE SIZE*

pufka duża  
(530x530 mm)  
*large pouffe*  
(530x530 mm) **1**

pufka mała  
(440x440 mm)  
*small pouffe*  
(440x440 mm) **2**

**TAPICERKA**  
*STANDARD PRO Film*  
**UPHOLSTERY**  
*STANDARD PRO Film*

VANCOUVER OTO



[www.profim.pl](http://www.profim.pl)

Profim nie odpowiada za błąd prawny, że omówiła zastrzeżenia i zmiany parametrów w celu poprawienia  
wskazania w celu przedkwalifikacji. Nie należy rozprawić o konieczności zmiany danych i dalszych zmianach. Jeśli nie oferujemy mobil.

This pro class reserves the right to correct any situation through word  
representations of the pro class. Cells are presented in the certificate may vary in the rights to use and information.